



# COLD SEAL PILL CARDS AND BLISTERS 2025

EZ Peel-Fold-N-Stick • No heat press required

## 1-PIECE EZ PEEL-FOLD-STICK COLD SEAL Pill Cards | 31 Dose

	ITEM #	CASE QTY	ORDER QTY	CASE PRICE
Med 1pc. Blister + Cold Seal Card (3/8" Deep) • 31 Dose	1-31-CSC-M-BLUE	250	3-5 cases	\$112
			6-10 cases	\$108
			11-20 cases	\$106
			21-40 cases	\$104
Large 1pc. Blister + Cold Seal Card (1/2" Deep) • 31 Dose	1-31-CSC-L-BLUE	250	5 cases (min)	\$114
			6-10 cases	\$110
			11-20 cases	\$108
			21-40 cases	\$106

Ask about our value pallet pricing

## 2-PIECE EZ PEEL-FOLD-STICK COLD SEAL Pill Cards & Blisters | 31 Dose

	ITEM #	CASE QTY	ORDER QTY	CASE PRICE
Cold Seal Card   31 Dose, Blue	2-31-CSC-BLUE	500	2-5 cases	\$166
			6-10 cases	\$160
			11-20 cases	\$156
			21-40 cases	\$154
Small Clear Blister (1/4" Deep)-31 Dose	31-S-BLISTER	1,000	1 case	\$75
Medium Clear Blister (3/8" Deep)-31 Dose	31-M-BLISTER	1,000	1 case	\$75
Large Clear Blister (1/2" Deep)-31 Dose	31-L-BLISTER	1,000	1 case	\$80
X-Large Clear Blister (2/3" Deep)-31 Dose	31-XL-BLISTER	1,000	1 case	\$80

1piece Cold Seal pill card • 31 Dose (Item#: 1-31-CSC-L-BLUE)

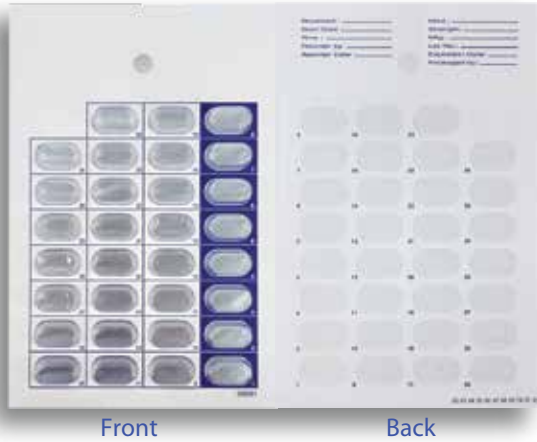

31 count Blisters (for 2 piece cards)



Available in 4 depths

Sealing Tray - 32ct (9x12) 1/2" Thick | Item#: CS-32-12-TRAY  
\$45.00

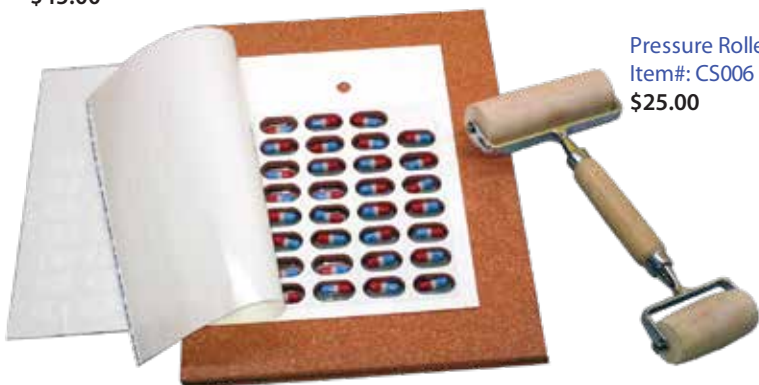

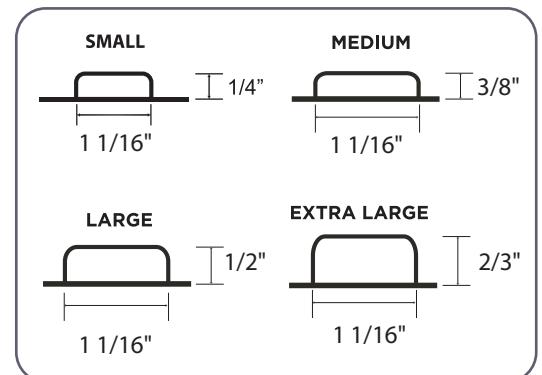

Pressure Roller for Cold Seal  
Item#: CS006  
\$25.00





# HEAT SEAL PILL CARDS AND BLISTERS

Heat seal cards are a cost effective alternative to cold seal cards which can save hundreds or thousands of dollars annually.

## 30 Dose | 2-PIECE HEAT SEAL Pill Cards & Blisters

	ITEM #	CASE QTY	ORDER QTY	CASE PRICE	
	Heat Seal Card   30 Dose, Blue	30-HSC-BLUE	1,000	2-5 cases	\$180
				6-10 cases	\$174
				11-20 cases	\$170
				21-40 cases	\$168
	Small Clear Blister (1/4" Deep)-30 Dose	30-S-BLISTER	1,000	1 case	\$75
	Medium Clear Blister (3/8" Deep)-30 Dose	30-M-BLISTER	1,000	1 case	\$75
	Large Clear Blister (1/2" Deep)-30 Dose	30-L-BLISTER	1,000	1 case	\$80

## 31 Dose | 2-PIECE HEAT SEAL Pill Cards & Blisters

	ITEM #	CASE QTY	ORDER QTY	CASE PRICE	
	Heat Seal Card   31 Dose, Blue	31-HSC-BLUE	1,000	2-5 cases	\$180
				6-10 cases	\$174
				11-20 cases	\$170
				21-40 cases	\$168
	Small Clear Blister (1/4" Deep)-31 Dose	31-S-BLISTER	1,000	1 case	\$75
	Medium Clear Blister (3/8" Deep)-31 Dose	31-M-BLISTER	1,000	1 case	\$75
	Large Clear Blister (1/2" Deep)-31 Dose	31-L-BLISTER	1,000	1 case	\$80
	X-Large Clear Blister (2/3" Deep)-31 Dose	31-XL-BLISTER	1,000	1 case	\$80

30 count Pill Card (Item#: 30-HSC-BLUE)



Front

Back

30 count Blisters - Available in 3 sizes

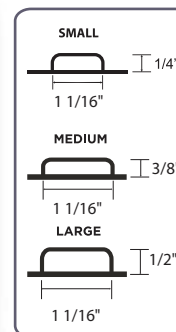

31ct Pill Card (Item#:31-HSC-BLUE)



Front

Back

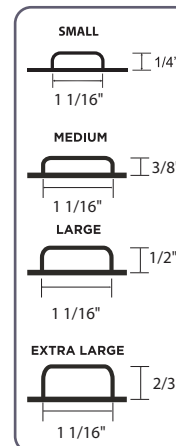

31 count Blisters - Available in 4 sizes



# STOCK HEAT SEAL PILL CARDS AND BLISTERS

Ask about our annual usage volume & pallet special pricing

## 60 Dose | 2-PIECE HEAT SEAL Pill Cards & Blisters

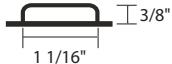
	ITEM #	CASE QTY	ORDER QTY	CASE PRICE
 60 Dose Heat Seal Card   Blue	60-HSC-BLUE	1,000	2-4 cases	\$194
			5-10 cases	\$188
			11-20 cases	\$184
			21-40 cases	\$180
 60 Dose Medium Clear Silicone Blister (3/8" Deep) 	60-M-BLISTER	1,000	1 case	\$90

## NARROW | 2-PIECE HEAT SEAL Pill Cards & Blisters, 30 Dose

	ITEM #	CASE QTY	ORDER QTY	CASE PRICE
 Narrow Heat Seal Card (3x9")   30 Dose, RED	30-HSC-BLUE	1,000	1-2 cases	\$304
			3-5 cases	\$294
			6-10 cases	\$288
			11-20 cases	\$282
Narrow Medium Clear Blister (3/8" Deep)-30 Dose	30N-M-BLISTER	1,000	1 case	\$75
Narrow Medium Amber Blister (3/8" Deep)-30 Dose	30NA-M-BLISTER	1,000	1 case	\$80

60 count Pill Card (Item#: U6053)



Front

Back

60-M-BLISTER



30N-HSC-RED



Front

Back

30N-M-BLISTER



### SEALING PADDLES

	ITEM #	PRICE
32 count 2-Across SEALING PADDLE	PDL-32-2UP	\$125 ea
62 count 2-Across SEALING PADDLE	PDL-62-2UP	
30 count Narrow 4-Across Sealing Paddle	PDL-30N-4UP	

32 Count 2 Across Sealing Paddle

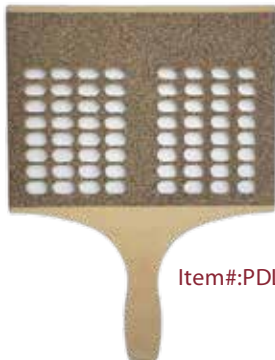

Item#:PDL-32-2UP

62 Count 2 Across Sealing Paddle

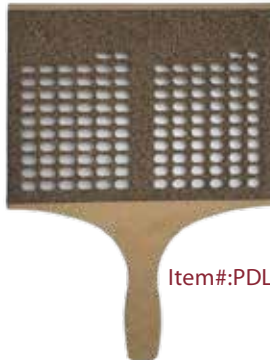

Item#:PDL-62-2UP

30 Count Narrow 4 Across Sealing Paddle



Item#:PDL-30N-4UP

RED LODGE LABEL  
346 W 11TH ST  
WEST FARGO, ND 58078  
701-630-6399



info@redlodgelabel.com  
www.redlodgelabel.com